

Axis Beam[®]

Charcot Fixation System

A Smarter Approach
for Charcot Deformity

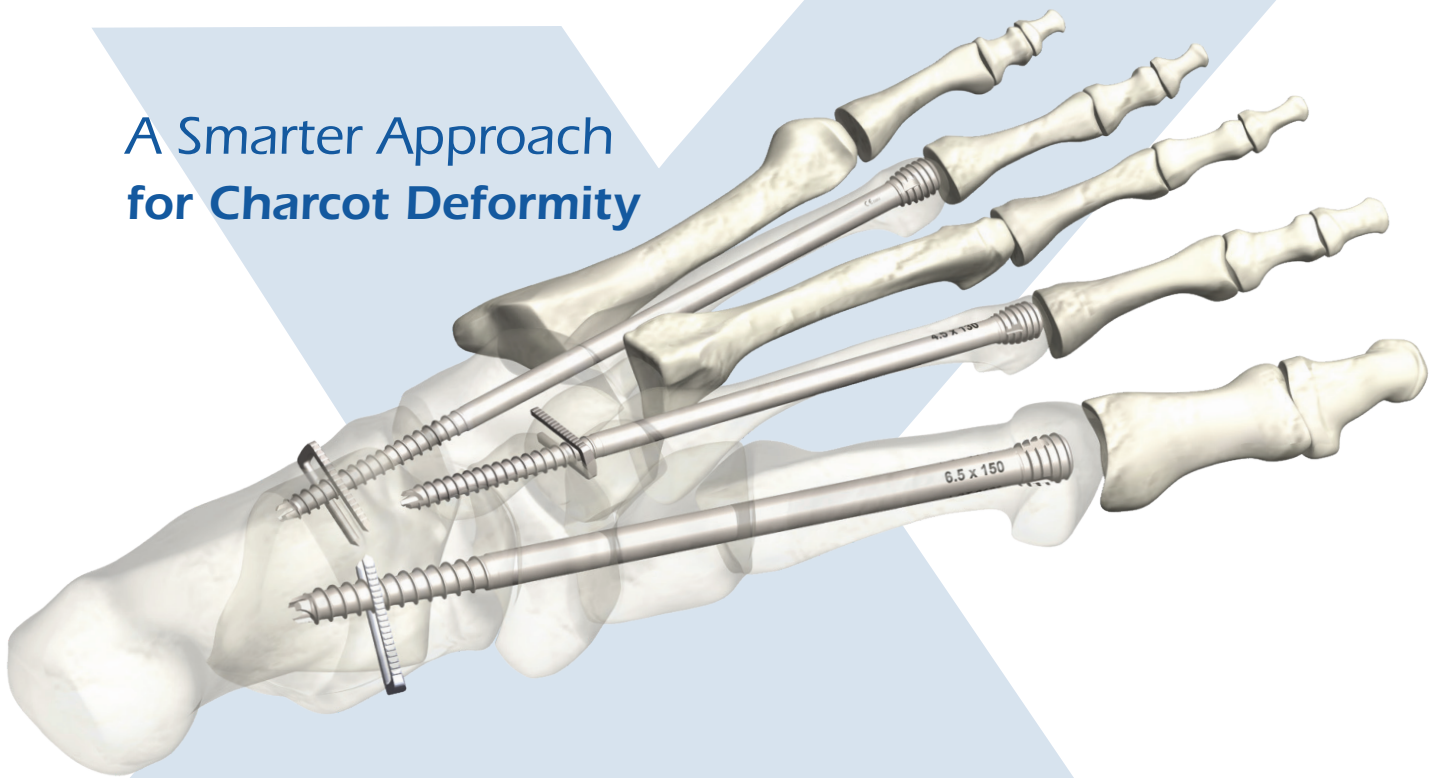

Superconstruct Surgical Technique

Stronger Beams **X** X-Clip Purchase Power **X** Maximized Mechanical Function

EXTREMITY[®]
MEDICAL

Real change *starts* here™

Axis Beam[®]

Charcot Fixation System

Product Description

The Axis Beaming System offers implants that range from 4.5 to 8.5mm in diameter. The beams are indicated for reconstruction procedures, nonunions and fusions of bones in the foot and ankle including the metatarsals, cuneiforms, cuboid, navicular, calcaneus and talus. Specifically, the 5.5mm, 6.5mm and 7.5mm sizes are indicated for examples which include: medial and lateral column fusion

Surgical Procedure Guidelines

A gastrocnemius recession or percutaneous tendon-achilles lengthening should be considered in midfoot reconstruction to minimize stress across the midfoot and to correct an equinus contracture if present. Surgical exposure consists of a medial incision centered at the apex of the deformity and one or two dorsal longitudinal incisions placed centrally and laterally as needed to reduce and prepare the middle and lateral columns. Preparation for the arthrodesis must include obtaining appropriate alignment of the foot. In addition to joint preparation, bone resection and soft tissue contracture release is often necessary to restore a plantigrade position to the foot. Guidewires for the beams can be used as provisional fixation of deformity correction. In many Charcot patients, the soft-tissue envelope is contracted because of chronic dislocation. In these cases, adequate bone resection to achieve realignment without excessive soft-tissue tension is advised. Osteotomy of the bony structures at the apex of deformity is incorporated into

resulting from neuropathic osteoarthopathy (Charcot). This technique guide illustrates axial fixation for a medial column. Each Axis Fusion Beam has a corresponding X-Clip. The X-Clip is designed to provide increased thread purchase, compression, and stability for patients with poor quality bone. The use of an X-Clip with an Axis Fusion Beam is optional and left to the surgeon's discretion.

arthrodesis preparation. The amount of bone resection is left to the discretion of the surgeon and must be individualized in each case. All joints where arthrodesis is intended should be prepared by removal of articular cartilage and subchondral bone, exposing bleeding cancellous bone. For example, in a medial column arthrodesis where arthrodesis of all joints is desired, the talonavicular, naviculocuneiform and first tarsometatarsal joints would be prepared as described. Guidewires used for reduction and guidance of fixation devices can be applied percutaneously antegrade, from the talus and calcaneus, or retrograde from the metatarsophalangeal joints. When entering the metatarsals from the retrograde approach, the Guidewires can be placed into the metatarsophalangeal joints percutaneously through the plantar aspect of the foot, or an open approach can be used utilizing a dorsal incision to expose the metatarsal head. The Guidewires should be placed into the medullary canal of the metatarsal without breaching the cortical bone.

Customer Service: 888.499.0079

www.extremitymedical.com

4.5mm Beams	5.5mm Beams	6.5mm and 7.5mm Beams	8.5mm Beams
60-140mm Lengths Utilize 2.0mm Guidewire and all instruments labeled Small	70-150mm lengths for use in the lesser rays (2-5 metatarsals) in conjunction with a medial column beam Utilize 2.0mm Guidewire and all instruments labeled Small	70-160mm lengths for use in the 1st metatarsal (medial column) Utilize 3.2mm Guidewire and all instruments labeled Large	(Special request) 100-170mm Lengths Utilize 3.2mm Guidewire and all instruments labeled Large

General Instruments

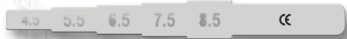

Axis Beam Sizing Key



Small Starter Awl



Large Starter Awl



4.5mm Cannulated Drill



5.5mm Cannulated Drill



6.5mm Cannulated Drill



2.0mm Small Guidewire



3.2mm Large Guidewire

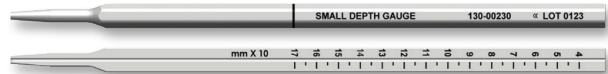

Small Depth Gauge



Large Depth Gauge



7.5mm Cannulated Drill



8.5mm Cannulated Drill

Real change *starts* here™

Beam Instruments



Tissue Protector



Ratcheting Handle

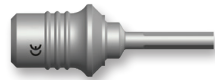

1/4" Sq.-to-Jacobs Adapter



Small Hex Driver



Large Hex Driver



Small Countersink



Large Countersink

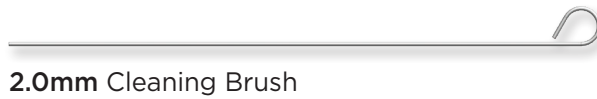

2.0mm Cleaning Brush



2.0mm Small Removal Tool



3.2mm Large Removal Tool



Small Removal Driver

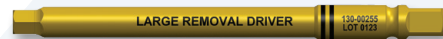

Large Removal Driver



2.0mm X 150mm Drill Pin



2.0mm X 200mm Drill Pin



2.5mm X 150mm Drill Pin



2.5mm X 200mm Drill Pin

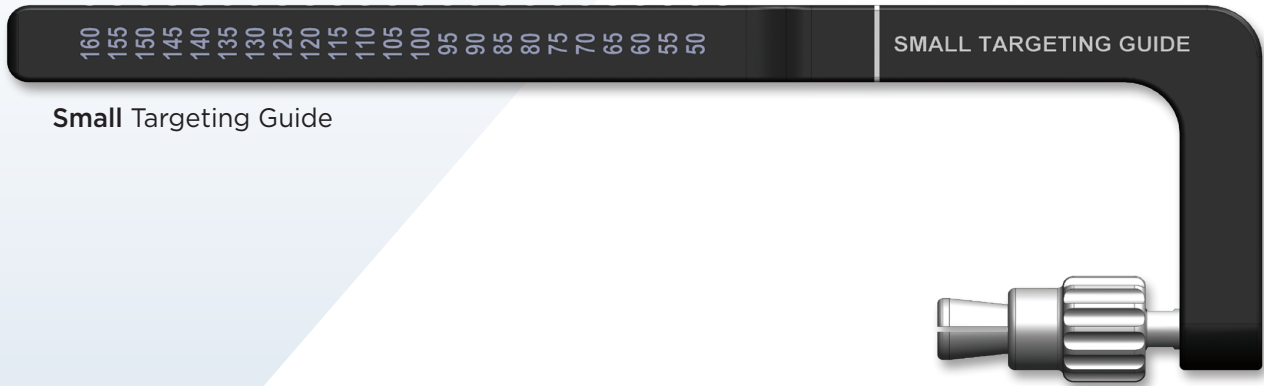

Axis Beam Technique Guidelines for Beam and X-Clip Placement

Step 1. Determining diameter of the Axis Beam

The Sizing Key may be used as a guide to determine the maximum diameter Axis Beam that can be used in the metatarsal. Place the Beam Sizing Key onto the top of the 1st metatarsal. Utilizing fluoroscopy, determine the most appropriate size Beam in relation to the patient's anatomy.



Step 2. Entry

The Starter Awl can be used to pierce the skin/cortex, and provide an entry point for the Guidewire.

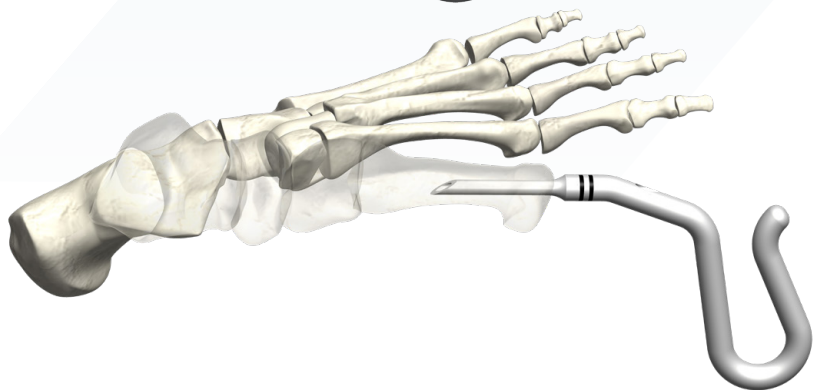

Step 3. Guidewire Placement

The Starter Awl and Guidewire can be used to “joystick” the bones—assisting with reduction of the deformity and alignment of the fusion. Advance the Guidewire through the Starter Awl aligning the bones as desired. Advance the wire to the desired position/depth with regard to the placement of the Axis Fusion Beam. Verify alignment and Guidewire positioning with fluoroscopy.

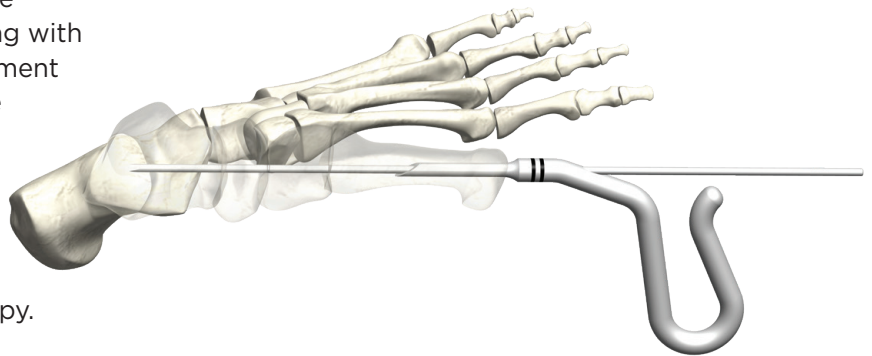

Step 4. Determine the Axis Beam length

Using the appropriate Depth Gauge, measure over the Guidewire to determine the Axis Beam length. *Note: It is recommended to countersink the Beam to the distal metaphyseal/diaphyseal junction.*

Selection of the Axis Beam length should take into consideration the subtraction for this countersink distance along with an estimation of the distance needed to create good bone apposition and compression along the fusion site.

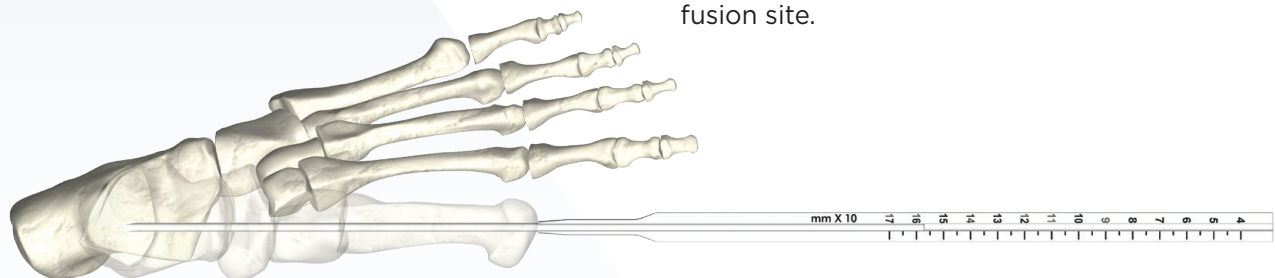

Step 5. Drill

Utilizing the Tissue Protector, place the appropriately sized Drill over the Guidewire, and drill the full length of the Beam as determined in the previous step. The Drills are stepped to maximize purchase, and the reference lines on the drills are calibrated with the Tissue Protector. Each line represents 5mm. The Tissue Protector should be in contact with bone in order to ensure accurate calibration with the Drill. For surgical power connections

that do not have a 1/4" Square connection, utilize the 1/4" Sq.-to-Jacobs Chuck Adapter with a tri-lobe Jacobs Chuck. *Note: If hard bone is encountered, it is recommended to drill in a sequential fashion - for example, for a 7.5mm Beam, start with the 6.5 mm Drill and progress to the 7.5 mm Drill*

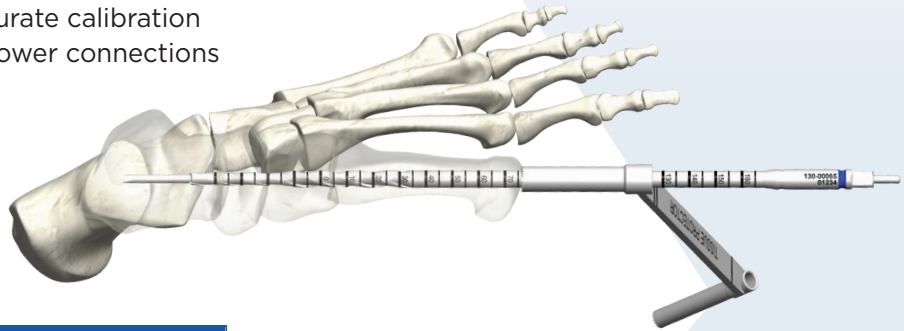

Drill Size	Drill Color
4.5mm	● Gold
5.5mm	● Green
6.5mm	● Blue
7.5mm	● Magenta
8.5mm	● Purple

Step 6. Countersink

Advance the Countersink over the Guidewire taking care to bury the laser marking. The countersink can be used in conjunction with the appropriate sized drill sleeve. Use the

Small Countersink for 4.5mm and 5.5mm Axis Beams. Use the Large Countersink for 6.5mm, 7.5mm and 8.5mm Axis Beams.

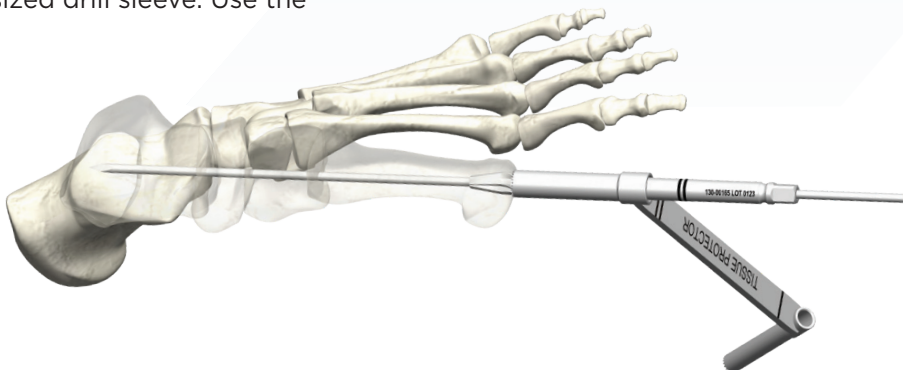

Step 7. Insert Axis Fixation Beam

Insert the Beam to the desired depth utilizing the appropriately sized Hex Driver. Verify final positioning with fluoroscopy. The Small Hex Driver (4.0mm) is used for the 4.5 & 5.5mm Beams. The larger Hex Driver (5.5mm) is used for the 6.5, 7.5, & 8.5mm Beams.

Note: If the placement of an X-Clip is desired, advance the beam approximately 80% of the desired insertion depth and follow the steps outlined in the next section of this guide.

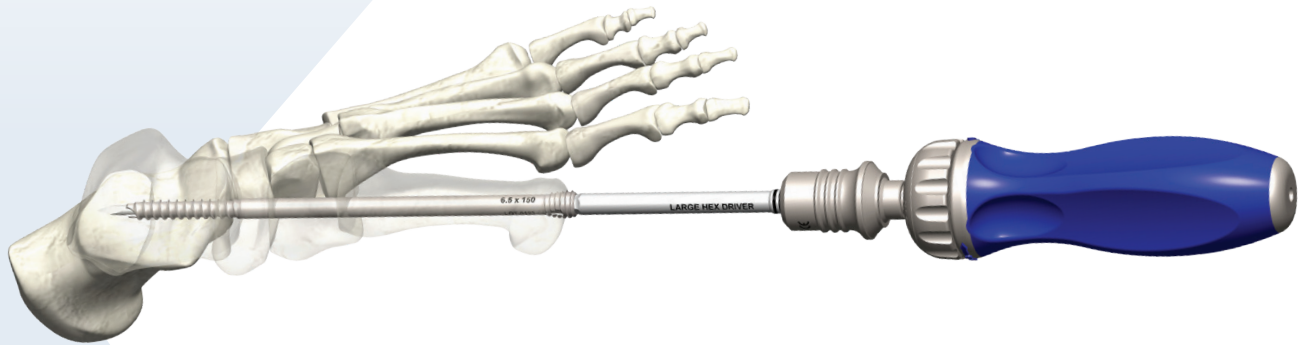

If no placement of an X-Clip is desired, advance the Beam to the desired position. Repeat all steps for other columns as desired.

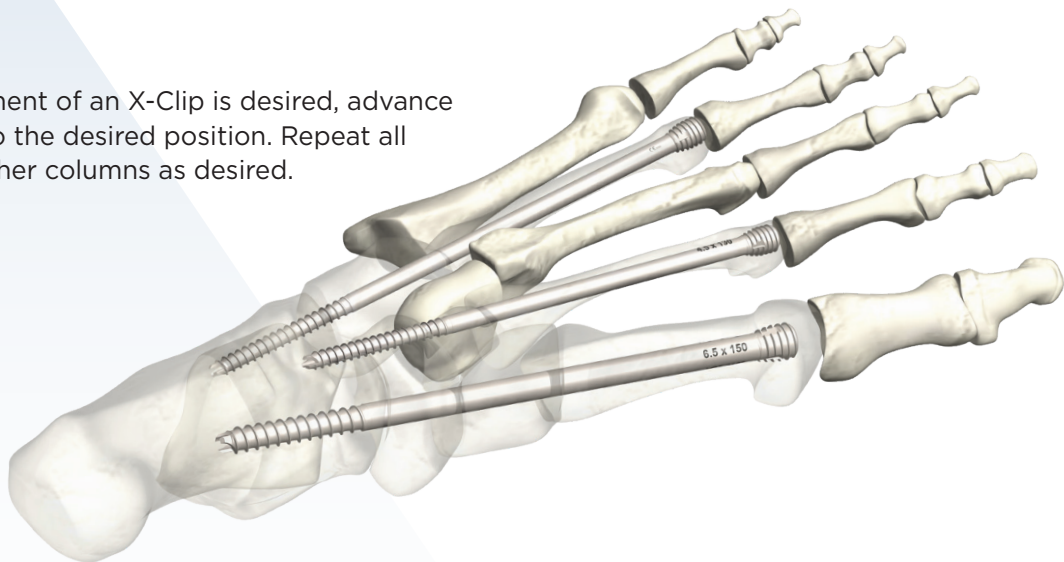

Axis Beam Technique for X-Clip Placement

Step 1. Attach Targeting Guides

To utilize an X-Clip with an Axis Beam, advance the Beam approximately 80% of the desired insertion depth.

Large Targeting Guide (works with the 6.5, 7.5 & 8.5 Beams) Slide the Drill Guide Portal onto the Targeting Guide (arrow towards the head of the beam). Advance the Portal to the desired Beam length.

Slide the Targeting Guide over the 3.2mm Guidewire and fully seat within the internal hex of the Beam.

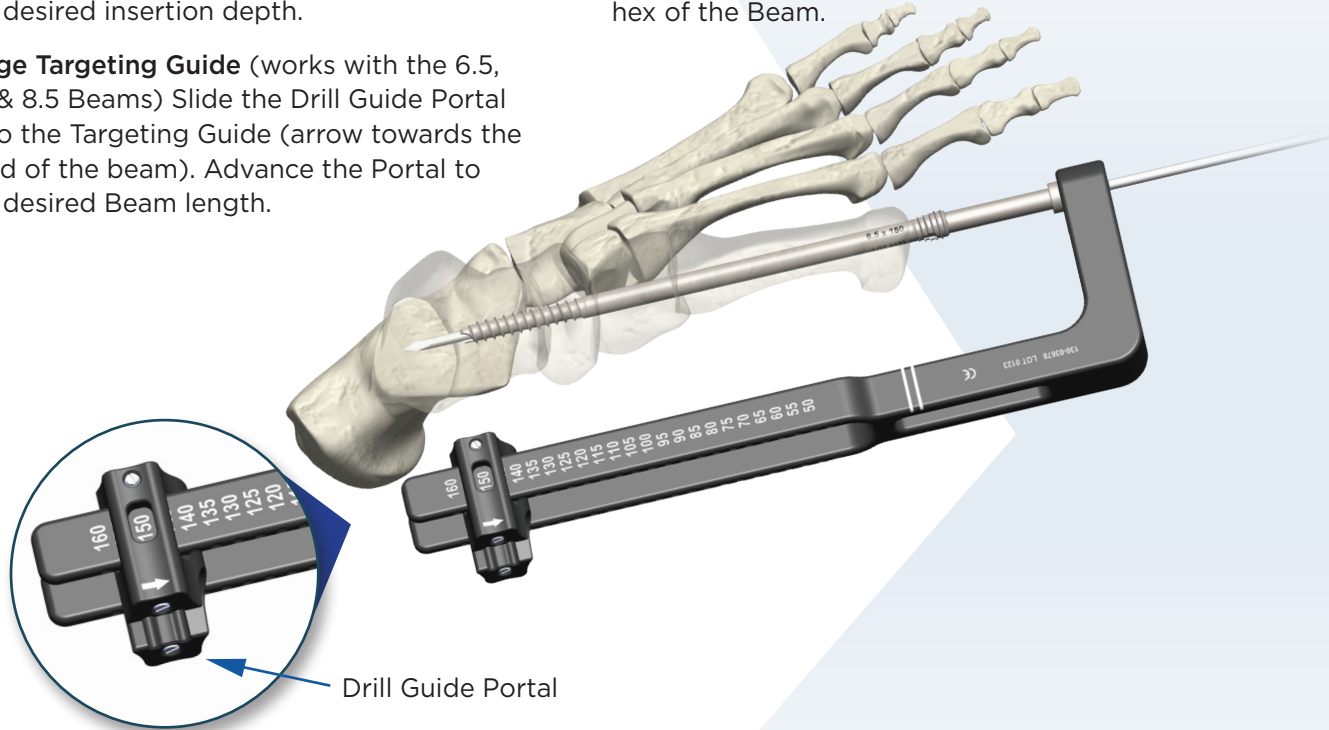

Small Targeting Guide (works with the 4.5 & 5.5mm Beams)

Slide the Drill Guide Portal onto the Targeting Guide (arrow towards the head of the beam). Advance the Portal until to desired Beam length.

Slide the Targeting Guide over the 2.0mm Guidewire taking care to mate the beam with the external coupler. This coupler will engage the head of the beam and is locked into place by rotating the coupler in a clockwise fashion.

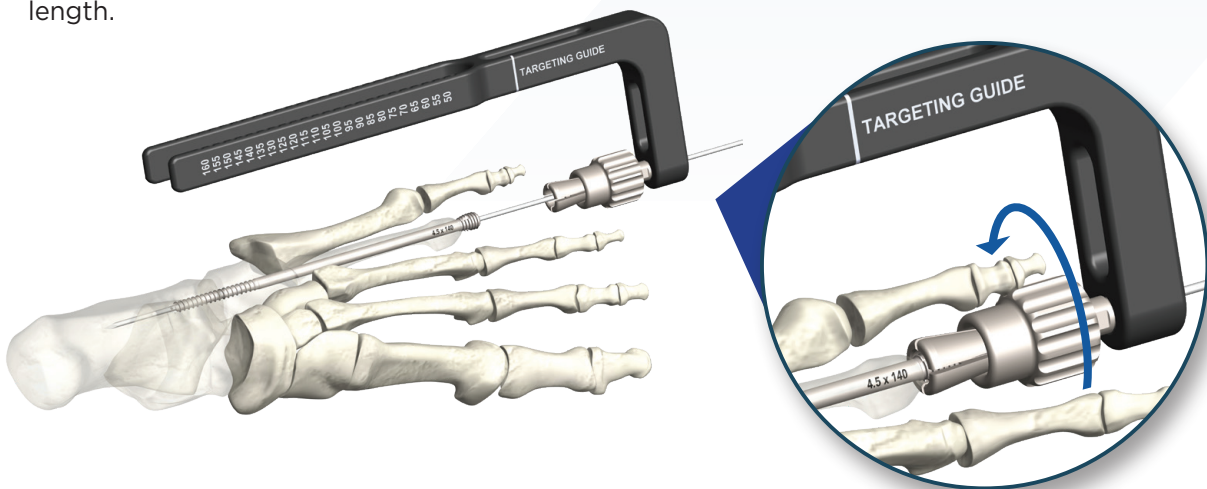

Step 2. Drilling for the X-Clip

Insert the appropriately sized Drill Guide through the Drill Guide Portal. Make an incision and dissect down to bone taking care to resect the soft tissue directly under the Drill Guide. Advance the Drill Guide down to bone.

Drill Guide Size	Color	Drill Pin Size
4.5mm	Gold	Small Drill Pin
5.5mm	Green	Small Drill Pin
6.5mm	Blue	Large Drill Pin
7.5mm	Magenta	Large Drill Pin
8.5mm	Purple	Large Drill Pin

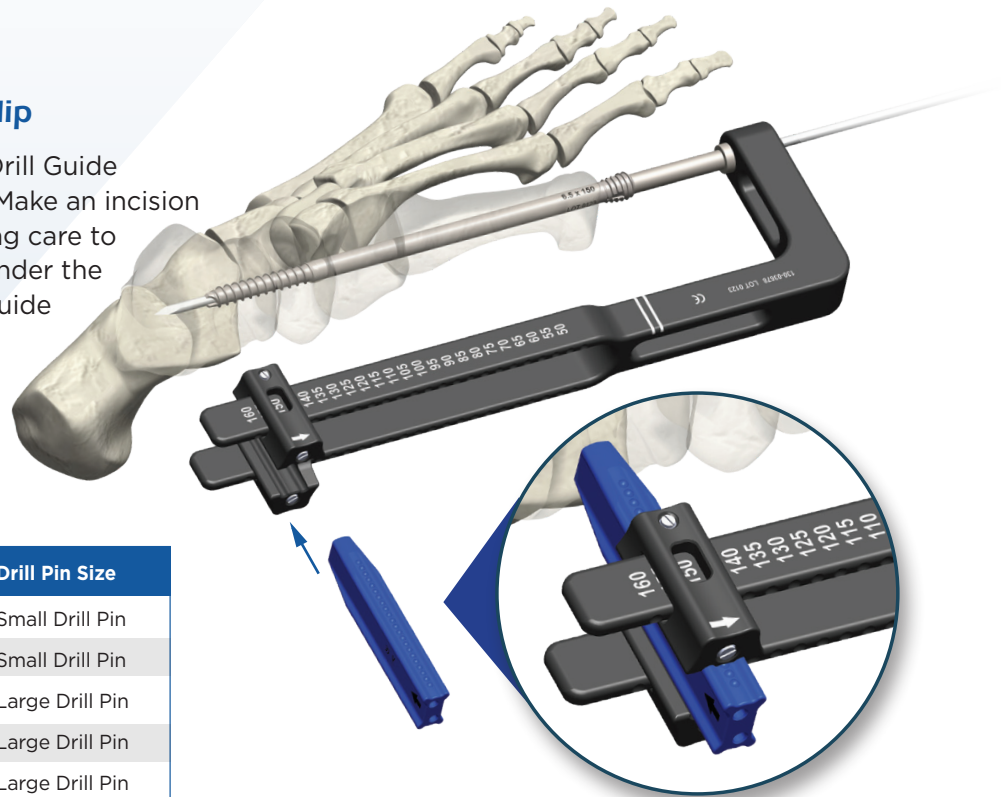

Utilizing a wire driver, advance the appropriately sized Drill Pin to the desired depth of X-Clip leg length. To avoid interference, use the Short Drill Pin for the first hole and the Long Drill Pin for the second hole. Verify the position of the Drill Pins with fluoroscopy in both the AP and lateral views. The tip of the Drill Pins should coincide with the desired X-Clip length and should be positioned on either side of the Beam.

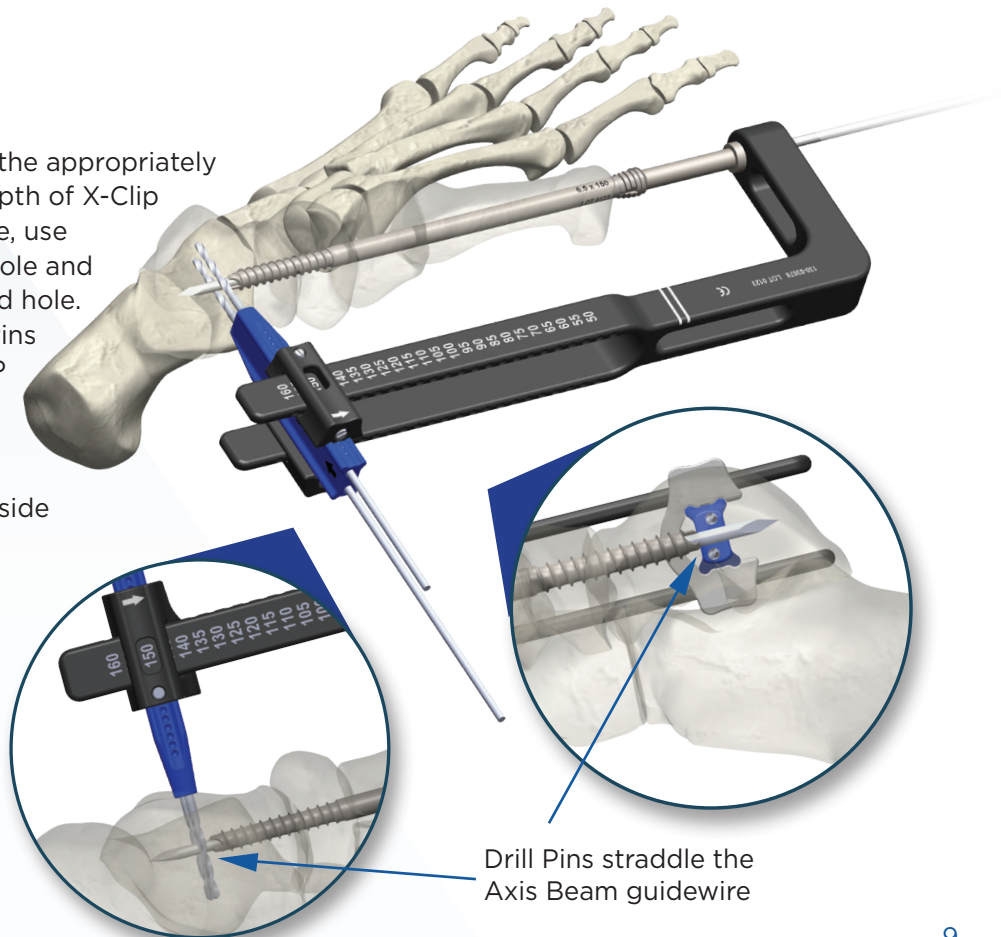

Drill Pins straddle the Axis Beam guidewire

Placement of Plate Screws General Technique

Step 2. Drilling for the X-Clip (Continued)

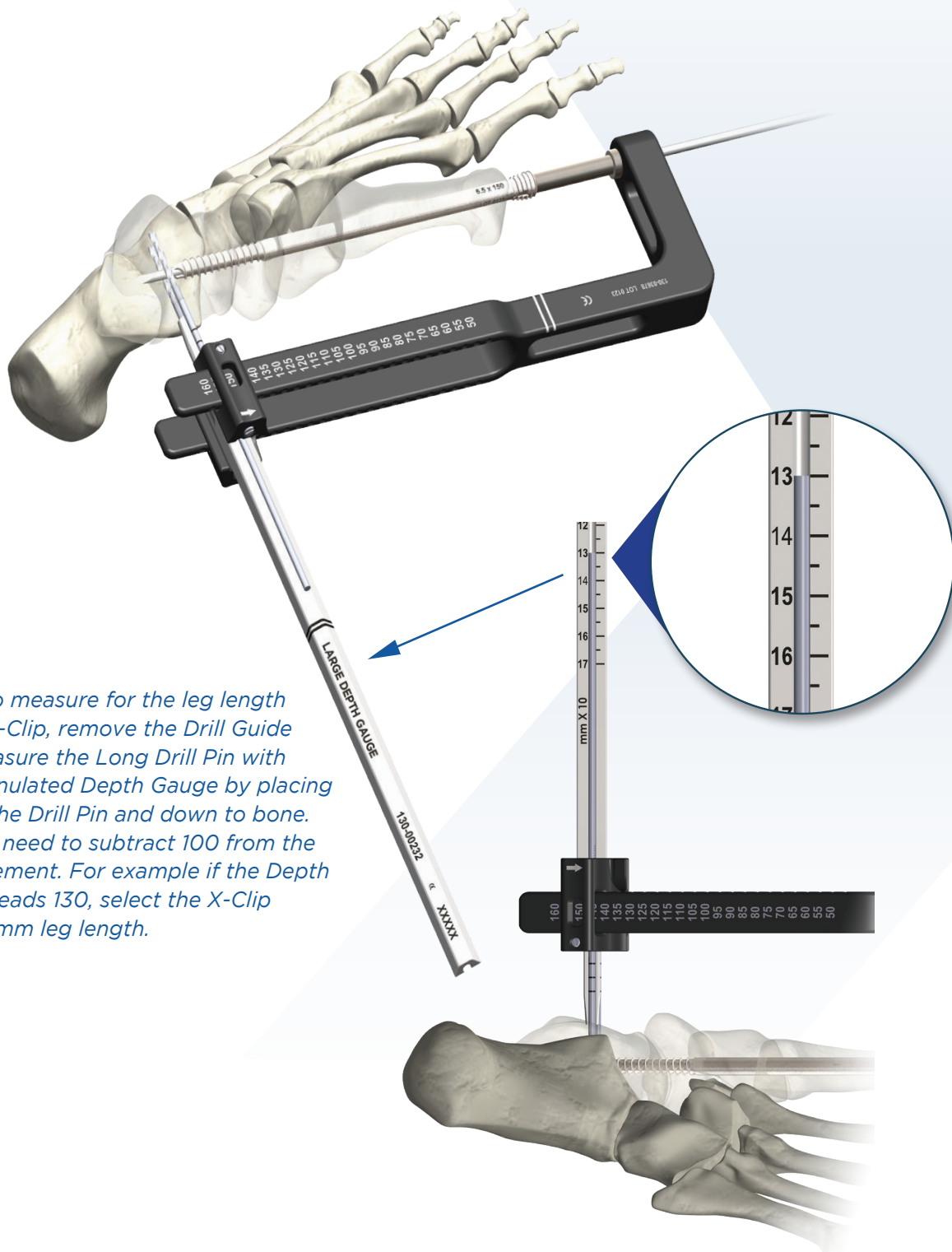

Note: To measure for the leg length of the X-Clip, remove the Drill Guide and measure the Long Drill Pin with the Cannulated Depth Gauge by placing it over the Drill Pin and down to bone. You will need to subtract 100 from the measurement. For example if the Depth Gauge reads 130, select the X-Clip with 30mm leg length.

Step 3. X-Clip Insertion

Load the selected X-Clip onto the Clip Inserter with the flat side of the bridge of the X-Clip onto the Clip inserter. Turn the knob at the top of the Inserter clockwise to secure X-Clip, ensuring that the legs are loaded parallel to the Inserter with the bridge of the X-Clip centered in the Inserter.

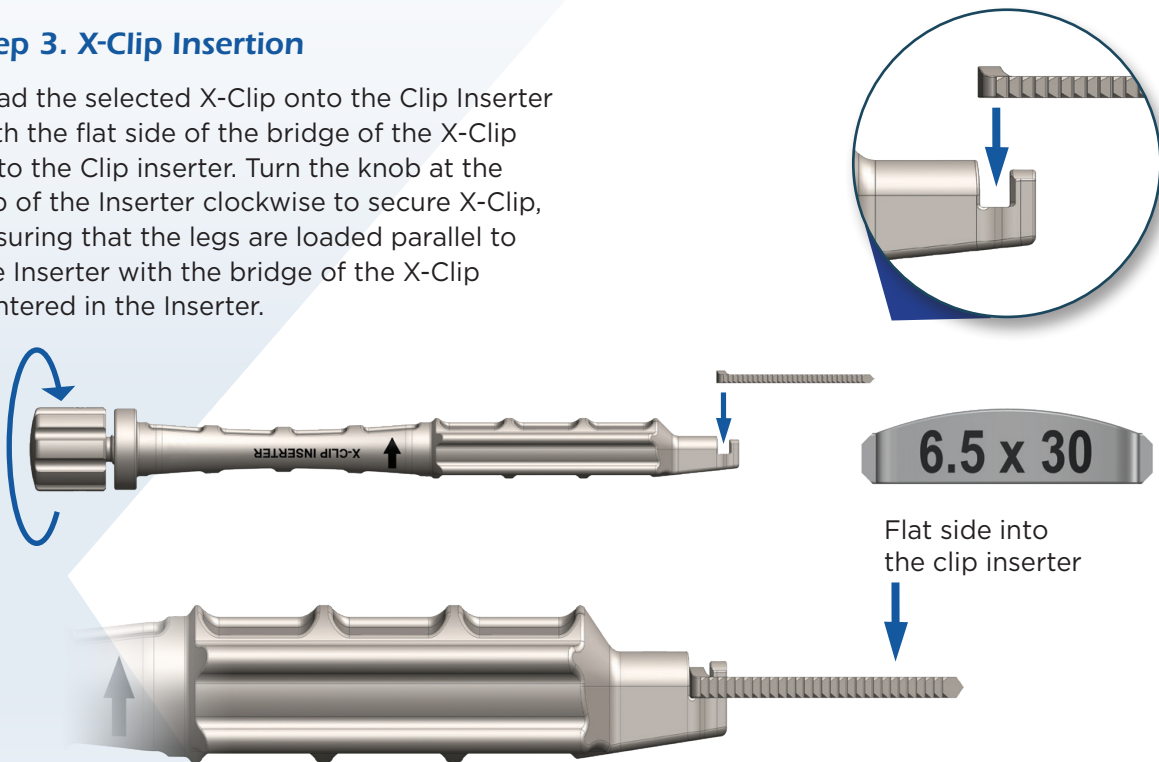

Remove the Drill Pins and the Drill Guide from the Drill Portal and deliver the X-Clip through the Drill Portal into the pre-drilled holes

Note: the arrow on the Inserter should match the direction of the arrow on the Drill Portal.

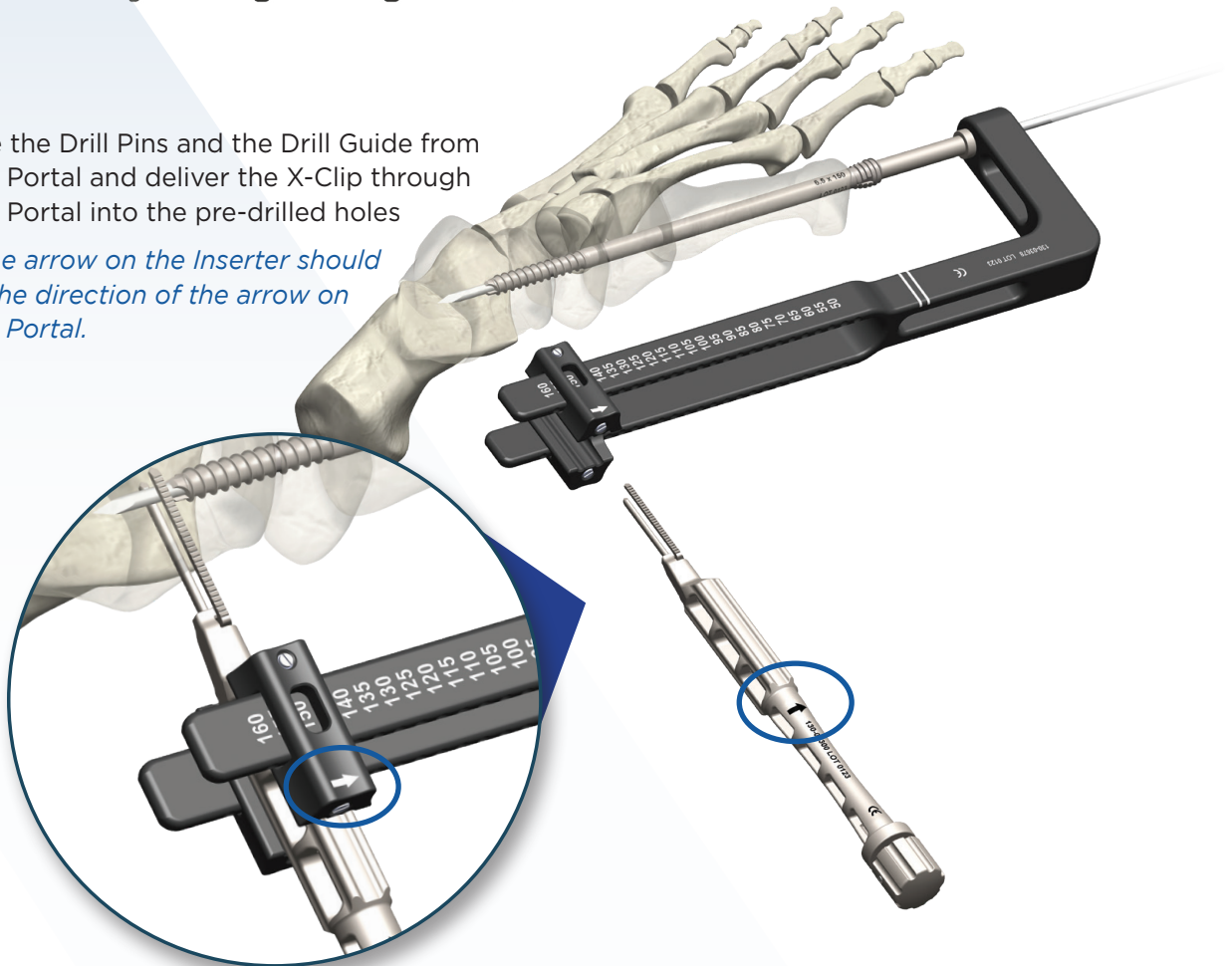

Step 3. X-Clip Insertion (Continued)

Advance the X-Clip into the pre-drilled holes without fully seating it. Release the X-Clip from the Inserter by turning the Inserter's knob counter-clockwise.

Slide the Portal and the Inserter away from the Beam and off of the Targeting Guide.

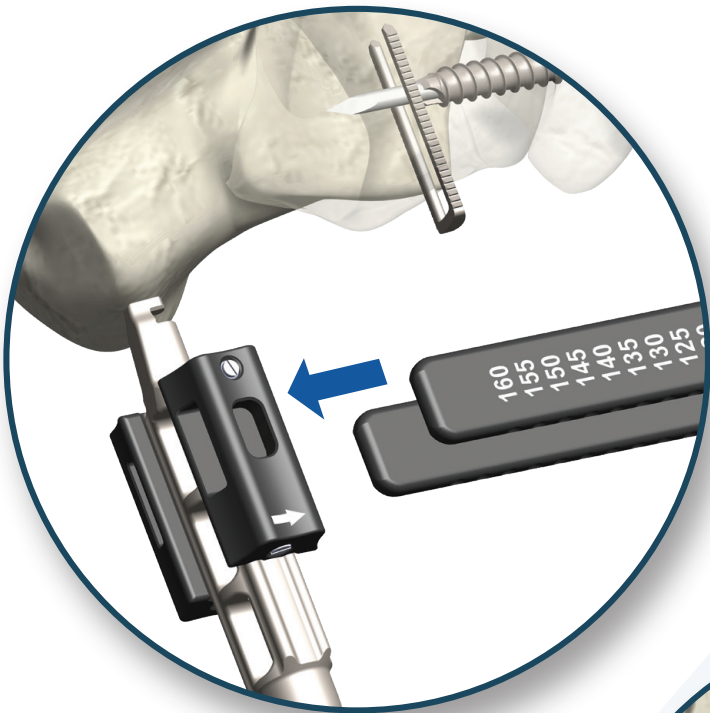

Remove the Targeting Guide from the Beam and tamp the X-Clip until it is fully seated using the end of the X-Clip Inserter.

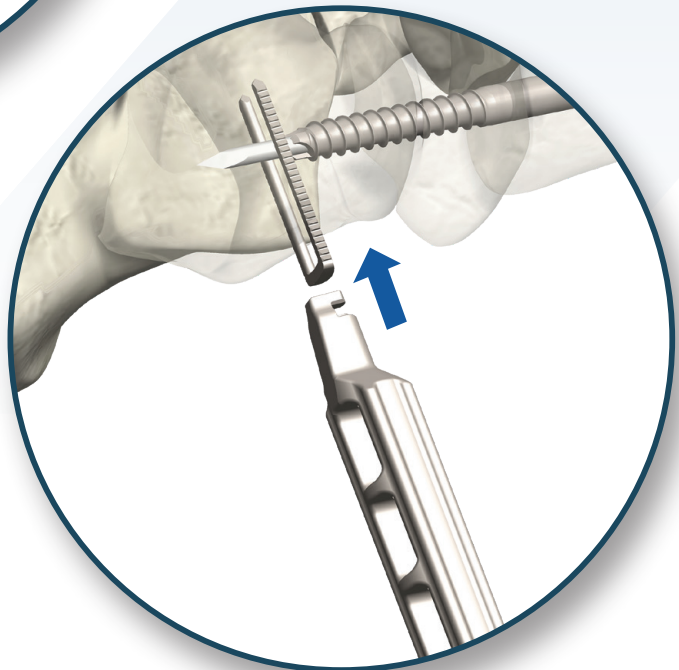

Step 4. Final Position of Axis Beam

Verify the positioning of the X-Clip to the Axis Beam with fluoroscopy. Advance the Axis Beam through the X-Clip compressing the fusion site. Advance till the head of the beam is countersunk to the metaphysis of the metatarsal.

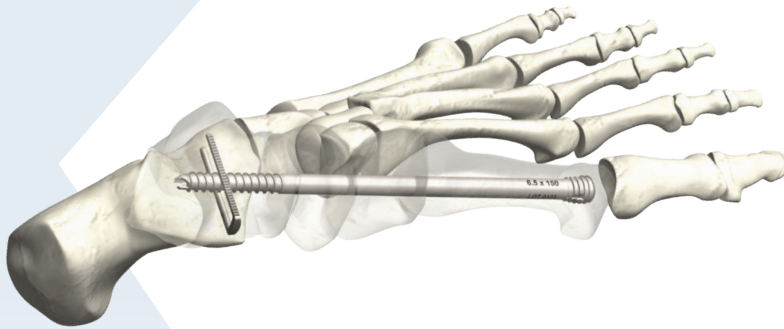

Axis Beams also provide an ideal option for hindfoot stabilization challenges.

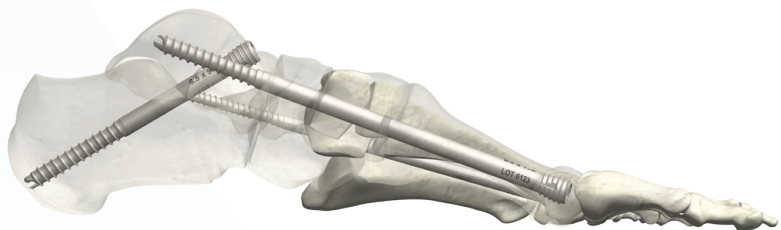
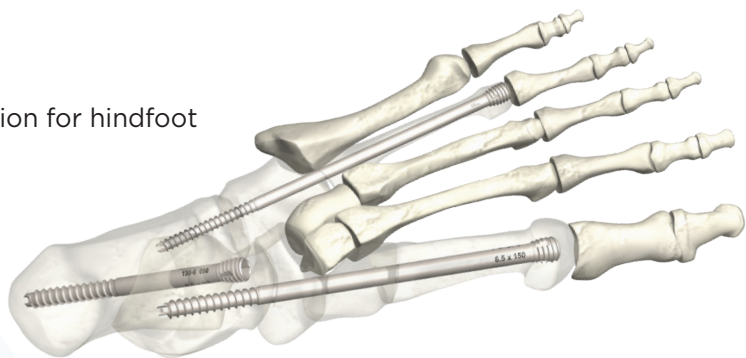

Axis Beam and X-Clip Removal Instructions

It is recommended to remove the Axis Beam prior to removing the X-Clip:

Axis Beam Removal

- Clear any tissue ingrowth from the Axis Beam

4.5 & 5.5mm Beams:

- Insert the Small Removal Driver (4.0mm Hex) into the Axis Beam and back out the Beam by turning counter-clockwise.

The Small Removal Tool can be inserted through the Removal Driver and threaded into the head of the beam to capture the internal threads and provide assistance during the removal process.

- Advance the X-Clip into the pre-drilled holes without fully seating it. Release the X-Clip from the Inserter by turning the Inserter's knob counter-clockwise.

X-Clip Removal

- Expose the bridge of the X-Clip
- If the X-Clip is recessed, use an elevator to lift the implant bridge
- Utilize forceps to remove the implant

6.5, 7.5 & 8.5mm Beams:

- Insert the Large Removal Driver (5.5mm Hex) into the Axis Beam and back out the Beam by turning counter-clockwise.

The Large Removal Tool can be inserted through the Removal Driver and threaded into the head of the beam to capture the internal threads and provide assistance during the removal process.

Caging the Beam with Axis Plates

The Axis Beam Implant can be supplemented by the **Axis Plate Charcot System** implants based on surgeon preference. Axis Plates have been designed to allow for the option to be placed around an Axis Charcot Beam. The plate screws allow for a 30° cone of angulation. Take care to place plate screws away from the already placed Axis Beam. Ensure proper utilization of the Drill Guides in conjunction with fluoroscopy to avoid screw collision.

For more information, refer to the [Axis Plate MAPP Surgical Technique](#), or contact [Extremity Medical](#).



Axis Plantar Plate
Metatarsal to Talus Implant



Axis Plantar-medial Plate
with Talar Wrap

Axis Beam System Implants and Instruments

4.5mm Axis Beams

Part #	Description
130-45060	Fixation Beam, 4.5 x 60mm
130-45065	Fixation Beam, 4.5 x 65mm
130-45070	Fixation Beam, 4.5 x 70mm
130-45075	Fixation Beam, 4.5 x 75mm
130-45080	Fixation Beam, 4.5 x 80mm
130-45085	Fixation Beam, 4.5 x 85mm
130-45090	Fixation Beam, 4.5 x 90mm
130-45095	Fixation Beam, 4.5 x 95mm
130-45100	Fixation Beam, 4.5 x 100mm
130-45105	Fixation Beam, 4.5 x 105mm
130-45110	Fixation Beam, 4.5 x 110mm
130-45115	Fixation Beam, 4.5 x 115mm
130-45120	Fixation Beam, 4.5 x 120mm
130-45125	Fixation Beam, 4.5 x 125mm
130-45130	Fixation Beam, 4.5 x 130mm
130-45135	Fixation Beam, 4.5 x 135mm
130-45140	Fixation Beam, 4.5 x 140mm

5.5mm Axis Beams

Part #	Description
130-55070	Fixation Beam, 5.5 x 70mm
130-55075	Fixation Beam, 5.5 x 75mm
130-55080	Fixation Beam, 5.5 x 80mm
130-55085	Fixation Beam, 5.5 x 85mm
130-55090	Fixation Beam, 5.5 x 90mm
130-55095	Fixation Beam, 5.5 x 95mm
130-55100	Fixation Beam, 5.5 x 100mm
130-55105	Fixation Beam, 5.5 x 105mm
130-55110	Fixation Beam, 5.5 x 110mm
130-55115	Fixation Beam, 5.5 x 115mm
130-55120	Fixation Beam, 5.5 x 120mm
130-55125	Fixation Beam, 5.5 x 125mm
130-55130	Fixation Beam, 5.5 x 130mm
130-55135	Fixation Beam, 5.5 x 135mm
130-55140	Fixation Beam, 5.5 x 140mm
130-55145	Fixation Beam, 5.5 x 145mm
130-55150	Fixation Beam, 5.5 x 150mm

6.5mm Axis Beams

Part #	Description
130-65070	Fixation Beam, 6.5 x 70mm
130-65075	Fixation Beam, 6.5 x 75mm
130-65080	Fixation Beam, 6.5 x 80mm
130-65085	Fixation Beam, 6.5 x 85mm
130-65090	Fixation Beam, 6.5 x 90mm
130-65095	Fixation Beam, 6.5 x 95mm
130-65100	Fixation Beam, 6.5 x 100mm
130-65105	Fixation Beam, 6.5 x 105mm
130-65110	Fixation Beam, 6.5 x 110mm
130-65115	Fixation Beam, 6.5 x 115mm
130-65120	Fixation Beam, 6.5 x 120mm
130-65125	Fixation Beam, 6.5 x 125mm
130-65130	Fixation Beam, 6.5 x 130mm
130-65135	Fixation Beam, 6.5 x 135mm
130-65140	Fixation Beam, 6.5 x 140mm
130-65145	Fixation Beam, 6.5 x 145mm
130-65150	Fixation Beam, 6.5 x 150mm
130-65155	Fixation Beam, 6.5 x 155mm
130-65160	Fixation Beam, 6.5 x 160mm

7.5mm Axis Beams

Part #	Description
130-75070	Fixation Beam, 7.5 x 70mm
130-75075	Fixation Beam, 7.5 x 75mm
130-75080	Fixation Beam, 7.5 x 80mm
130-75085	Fixation Beam, 7.5 x 85mm
130-75090	Fixation Beam, 7.5 x 90mm
130-75095	Fixation Beam, 7.5 x 95mm
130-75100	Fixation Beam, 7.5 x 100mm
130-75105	Fixation Beam, 7.5 x 105mm
130-75110	Fixation Beam, 7.5 x 110mm
130-75115	Fixation Beam, 7.5 x 115mm
130-75120	Fixation Beam, 7.5 x 120mm
130-75125	Fixation Beam, 7.5 x 125mm
130-75130	Fixation Beam, 7.5 x 130mm
130-75135	Fixation Beam, 7.5 x 135mm
130-75140	Fixation Beam, 7.5 x 140mm
130-75145	Fixation Beam, 7.5 x 145mm
130-75150	Fixation Beam, 7.5 x 150mm
130-75155	Fixation Beam, 7.5 x 155mm
130-75160	Fixation Beam, 7.5 x 160mm

8.5mm Axis Beam (special order)

Part #	Description
130-85100	Fixation Beam, 8.5 x 100mm
130-85110	Fixation Beam, 8.5 x 110mm
130-85120	Fixation Beam, 8.5 x 120mm
130-85130	Fixation Beam, 8.5 x 130mm
130-85140	Fixation Beam, 8.5 x 140mm
130-85150	Fixation Beam, 8.5 x 150mm
130-85160	Fixation Beam, 8.5 x 160mm
130-85170	Fixation Beam, 8.5 x 170mm

Note: The 8.5mm Axis Beam is a special order implant and does not come standard with the Axis Beam implant set.

Axis X-Clip Implants

Part #	Description
4.5mm	
130-45915	X-Clip, 4.5 x 15mm
130-45920	X-Clip, 4.5 x 20mm
5.5mm	
130-55915	X-Clip, 5.5 x 15mm
130-55920	X-Clip, 5.5 x 20mm
6.5mm	
130-65925	X-Clip, 6.5 x 25mm
130-65930	X-Clip, 6.5 x 30mm
7.5mm	
130-75925	X-Clip, 7.5 x 25mm
130-75930	X-Clip, 7.5 x 30mm
8.5mm	
130-85925	X-Clip, 8.5 x 25mm
130-85930	X-Clip, 8.5 x 30mm

Note: The 8.5mm Axis X-Clip is a special order implant and does not come standard with the Axis Beam implant set.

Disposable Instruments

Part #	Description
130-00020	Guidewire, Small (2.0mm)
130-00032	Guidewire, Large (3.2mm)
130-00045	Cannulated Drill, 4.5mm
130-00055	Cannulated Drill, 5.5mm
130-00065	Cannulated Drill, 6.5mm
130-00075	Cannulated Drill, 7.5mm
130-00085	Cannulated Drill, 8.5mm
130-00220	Cleaning Brush, 2.0mm
130-02020	Short Drill Pin, Small
130-02025	Long Drill Pin, Small
130-02120	Short Drill Pin, Large
130-02125	Long Drill Pin, Large

Reusable Instruments

Part #	Description
130-00003	Tissue Protector
130-00004	Ratcheting Handle
130-00005	1/4" Sq.-to-Jacobs Adapter
130-00007	Beaming Sizing Key
130-00025	Removal Tool, Small
130-00040	Removal Tool, Large
130-00120	Starter Awl, Small
130-00132	Starter Awl, Large
130-00140	Hex Driver, Small (4.0mm)
130-00145	Countersink, Small
130-00155	Hex Driver, Large (5.5mm)
130-00165	Countersink, Large
130-00230	Depth Gauge, Small (2.0mm)
130-00232	Depth Gauge, Large (3.2mm)
130-00240	Removal Driver, Small (4.0mm)
130-00255	Removal Driver, Large (5.5mm)
130-03300	X-Clip Inserter
130-03000	Drill Guide Portal
130-03045	Drill Guide, 4.5mm
130-03055	Drill Guide, 5.5mm
130-03065	Drill Guide, 6.5mm
130-03075	Drill Guide, 7.5mm
130-03085	Drill Guide, 8.5mm
130-03455	Targeting Guide, Small
130-03678	Targeting Guide, Large

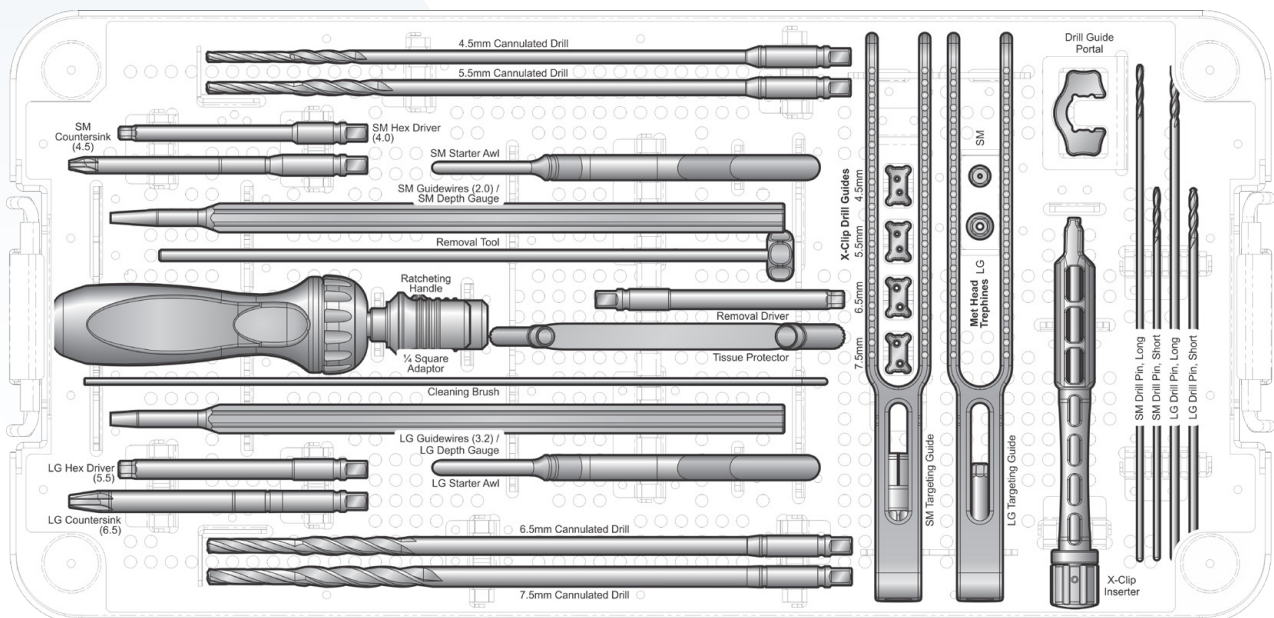

Axis Beam[®]

Charcot Fixation System

Delivering
a smarter approach for Charcot
Period.

Real change ***starts*** here[™]

EXTREMITY[®]
MEDICAL

Real change ***starts*** here[™]

888.499.0079

973.588.8980

ExtremityMedical.com

customerservice@ExtremityMedical.com

300 Interpace Parkway, Suite 410 | Parsippany, NJ 07054

CE₂₇₉₇

Patent Pending. Extremity Medical[®], and Axis Beam[®] are trademarks of Extremity Medical, LLC.
© 2020 Extremity Medical, LLC. All Rights Reserved.

LBL-130-99102-EN Rev C 12/2020